



pur
natur

Installation instructions
pur natur floorboards

Every pur natur floor-board is unique in its appearance ...

... and especially in its nature. Put them together with the right know-how and you create a floor that can last for generations. Anyone who appreciates the harmony of a board floor will be delighted with their homely look. And those who value their natural character will be rewarded with a foundation for unique stories.

To guarantee an excellent laying result and ensure your pur natur floorboards last for years, these instructions provide detailed guidance on what to look out for when laying pur natur floorboards and what you should avoid if possible.

If you have any questions that are not answered here or if you need additional advice, please feel free to contact us.

Happy floor laying!

Content

1. Important notes on preparation	5
1.1 Wood and humidity	5
1.2 Climatic conditions required in the room	6
1.3 Necessary subsurface quality	6
1.4 Warning signs	7
1.5 Key questions before laying your floorboards	7
2. Laying methods and prerequisites	8
2.1 Floorboards on screed or dry screed panels	8
2.2 Floorboards on a joist layer	8
2.3 Floorboards on OSB panels	9
2.4 Floorboards on dry construction underfloor heating systems	9
3. Exposed joints	11
4. Laying the floorboards	12
4.1 General information	12
4.2 Laying method	12
4.3 Basic laying procedure	14
5. Screwing from above	18
6. Concealed screw connection	20
7. Full-surface gluing	22
7.1 Preparing the subsurface	22
7.2 Laying the floorboards	23
8. Edging	26
8.1 Shadow gap	26
8.2 Skirting boards	26

9. Professional tips	28
10. Reference tables	29
10.1 Sleeper distances	29
10.2 Screw sizes	29
10.3 Screw distances	30
10.4 Screw distance to floorboard edge	30
10.5 Subsurface quality when gluing	31
10.6 Adhesives, primers and drying time	31
10.7 Exposed joints	32
10.8 Wall clearances	32
11. Construction site check	34
11.1 Checklist prerequisites	34
12. Recommended tool	35

1. Important notes on preparation

1.1 Wood and humidity

One of wood's natural properties is to constantly interact with its surroundings and adapt to the room climate. Before laying floorboards, it is therefore essential to create and ensure the necessary room climate in order to avoid damage to the floor. We recommend installing a hygrometer to continuously check the relative humidity in the rooms where the floorboards are to be laid and to log the data.

The table below shows the effects that different humidity levels can have on the wood and the countermeasures we recommend in each case to create the required indoor climate. In general: pur natur floorboards may only be laid in areas with 40-60% relative humidity. Extreme humidity outside of these values - too humid or too dry - can lead to damage to the floor.

Relative humidity	Expected change in the floorboards	Recommendation
> 70 % extremely humid	The floorboards absorb a lot of moisture. Drastic changes in shape can occur. The floorboards will bend.	Set up a building dryer or dehumidifier to lower the humidity.
60-70 % too humid	The wood absorbs moisture. A slight warping of the floorboards is to be expected. Exposed joints may close.	Keep an eye on the climate. Prevent humidity levels of > 60% over extended periods of time.
50-60 % a little too humid	At relative humidity levels of close to 60%, the floorboards can warp slightly. Any exposed joints may become smaller.	-
40-50 % ideal	The floorboards are even. No gap formation - exposed joints remain the same size.	-
35-40 % a little too dry	The floorboards can easily bend. Minor gap formation can occur. Isolated surface cracks can occur.	Keep an eye on the climate. If air humidity tends towards 30%, you should humidify the air.
25-35 % too dry	Surface cracks appear. Gaps of up to 1% of the floorboard width can form. Exposed joints increase in size.	Take measures to humidify the air - e.g. wiping with a damp cloth or using an air humidifier.
< 25 % extremely dry	The floorboards dry out too much. Cracks appear. Severe cupping. The wood is overstretched.	Increase the humidity with a humidifier until it is > 35%.

Table 1: Humidity and floorboards

1.2 Climatic conditions required in the room

Before the floorboards are delivered, it must be ensured that the building is closed, dry and free of building moisture and that any work that can influence humidity has been completed (plastering, painting, etc.). The room temperature should be between 18 °C and 25 °C, the humidity must be between 40 and 60%. After the heating protocol has been carried out, heated rooms must be continuously heated for at least three weeks. The humidity must not exceed 60% during this time.

IMPORTANT: In summer, the floorboards must be laid immediately after delivery. In winter, the floorboards must acclimatise for at least 5-7 days under correct climatic conditions in the room in which they are to be laid. Humidity must not exceed 50% in winter.



Floorboard laying may only commence once the climatic conditions in the room meet our specifications. Damage resulting from an unsuitable indoor climate during or after laying is not covered by the warranty.

1.3 Necessary subsurface quality

Before you can start laying, the subsurface must be prepared and meet the following requirements:

- > The moisture in the subsurface has been adequately measured and documented (type and number of measuring points and execution of the measurement samples). The required CM measurement for screeds provides a value of $\leq 1.8\%$ CM with underfloor heating or $\leq 2.0\%$ CM without underfloor heating. The required wood moisture measurement for wooden subsurfaces provides a value of max. 10-12% wood moisture.
- > The subsurface is completely level as defined by DIN 18202 with a maximum deviation of 2mm on a 2m level. Any additional levelness tolerances have been taken into account. Please contact us for advice if you have an uneven subsurface.
- > All the necessary work to remove defects from the subsurface has been carried out (e.g. sanding, filling of the entire surface). The subsurface has been cleaned, is free of dirt and has been primed if necessary.



Laying on underfloor heating must not be carried out without a prior, professional heating protocol!

1.4 Warning signs

Before laying, be sure to check the following points and raise any concerns (see Section 4 Para. 3 VOB/B (Vergabe- und Vertragsordnung für Bauleistungen - Regulations for the Awarding and Contracting of Construction Works, Part B) if:

- > The subsurface has not dried sufficiently and/or the room climate does not meet our specifications.
- > The subsurface height is incorrect in relation to the height of adjacent components, for example it has not been levelled correctly or there are unintentional differences in height.
- > Unevenness in the subsurface is greater than 2mm on a 2m level.
- > The subsurface shows excessive cracks and the surface is insufficiently strong, too porous, too rough or contaminated.
- > The edge insulation strip does not protrude.
- > Markings of measuring points and the heating protocol for heated floor constructions are not available or the values do not meet the requirements.

1.5 Key questions before laying your floorboards

Before you start laying your floorboards, be sure to clarify the following questions:

- > What is the basic structure of the floor (screed, with/without underfloor heating, on a joist layer/battens in an old building, etc.)? See chapter «Laying methods».
- > In which direction will the floorboards be laid and in what way? Is the shape of the area to be covered different to a rectangle? What are the dimensions of the floorboards? Will the floorboards be laid with or without a exposed joint?
- > What are the number, type, position and dimensions of installation and built-in parts, connection and movement joints and necessary recesses in the floorboards?
- > Are there cables, pipes or similar in the floor and wall areas that are not visible?



Careless laying of the floorboards can lead to avoidable additional work, to an unsatisfactory laying result and, in the worst case, to floorboard or building structure damage.

]

2. Laying methods and prerequisites

The requirements of each building project are different. The following schematic laying methods are indicative for the floor construction of private residential properties. The floor structure for commercial, public or construction projects with specific legal requirements and guidelines must be planned individually.

2.1 Floorboards on screed or dry screed panels

If pur natur floorboards are laid on screed or dry screed boards such as Fermacell®, we recommend full-surface gluing of the floorboards.

Prerequisites

The screed is dried, sanded, level and clean according to the specifications.

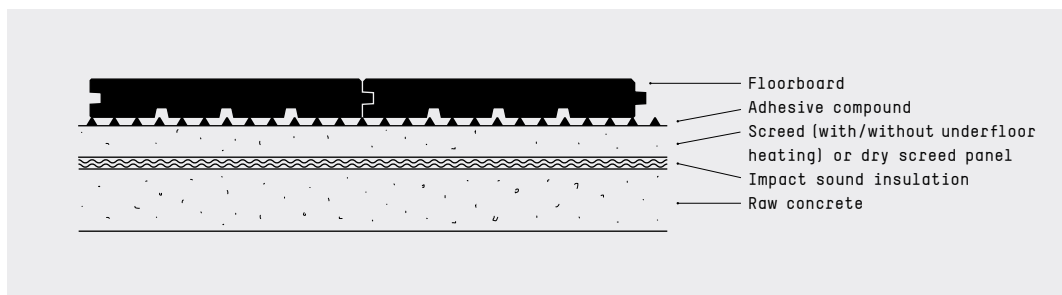

Figure 1: Full-surface gluing on screed or dry screed

2.2 Floorboards on a joist layer

Floorboards on a joist layer are always screwed to the subsurface. We particularly recommend this laying method if the subfloor in your property already consists of a joist layer that meets the necessary requirements for subsurface quality. Room-length floorboards produce significantly less waste than random-length floorboards, since it is not necessary to consider where a floorboard meets a joist. Joist spacing can vary, particularly in older buildings, meaning that an exact floorboard length grid cannot be maintained.

Prerequisites

The subfloor has been professionally laid and levelled with sleepers or joists in line with common professional practice. The maximum joist distances from Table 4 «Sleeper distances» have been observed.

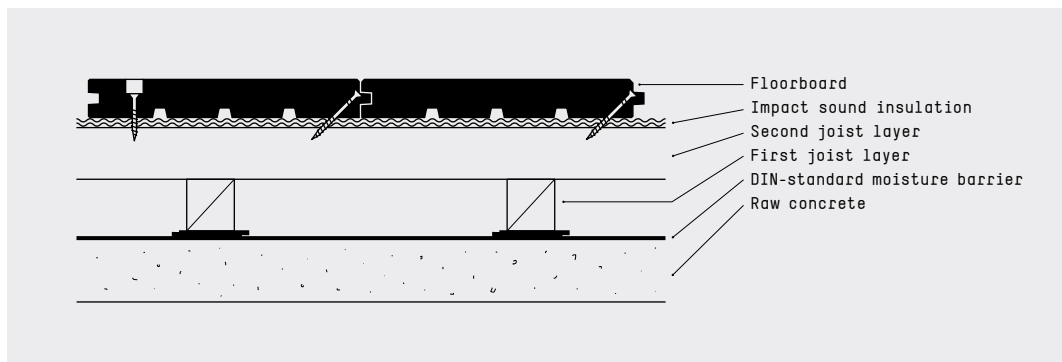

Figure 2: Screwing on joist layer

2.3 Floorboards on OSB panels

The floorboards can be screwed or glued onto OSB boards. However, in wet areas or if impact sound insulation plays a decisive role, we recommend gluing the floorboards over the entire surface.

OSB panels are an ideal subfloor for old buildings as well as for wooden or prefabricated wooden houses, as they make it very easy to level the subsurface and create a flat surface. Unlike screwing on a joist layer, the screw spacing can be set in any grid pattern. Sound insulation of at least 3mm thickness is laid between the raw concrete layer and the OSB panel. We recommend natural materials such as cork or felt (tread-resistant) - please consult an acoustics or soundproofing expert for detailed advice.

Prerequisites

The screed is dried, sanded and level according to the specifications. The OSB panels have been professionally laid, levelled, bound to the screed and are clean, in line with common professional practice. The selected soundproofing has been professionally prepared and laid.

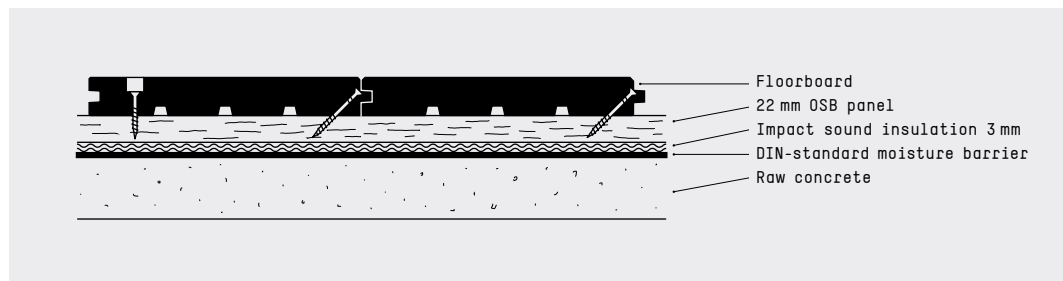

Figure 3: Screwing on OSB panels

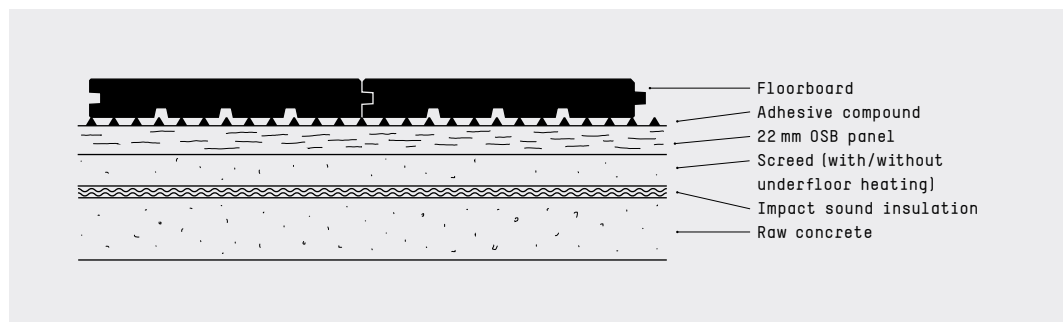

Figure 4: Gluing on OSB boards

2.4 Floorboards on dry construction underfloor heating systems

The advantage of dry construction underfloor heating systems (such as Joco, Thermisto, Lithotherm, Steicofloor, etc.) is that no moisture is brought into the building and no adhesives are required, since the floorboards are screwed to the subfloor.

For the planning and installation of the underfloor heating, please contact the respective manufacturer. The floorboards are screwed to the battens between the heating elements. The procedure is essentially the same as screwing on a joist layer.

It is important that the floorboards rest primarily on the heating elements. The battens must therefore be approx. 0.5-1mm lower than the heating elements.

Prerequisites

The dry construction underfloor heating system has been professionally laid and tested for functionality in line with common professional practice.

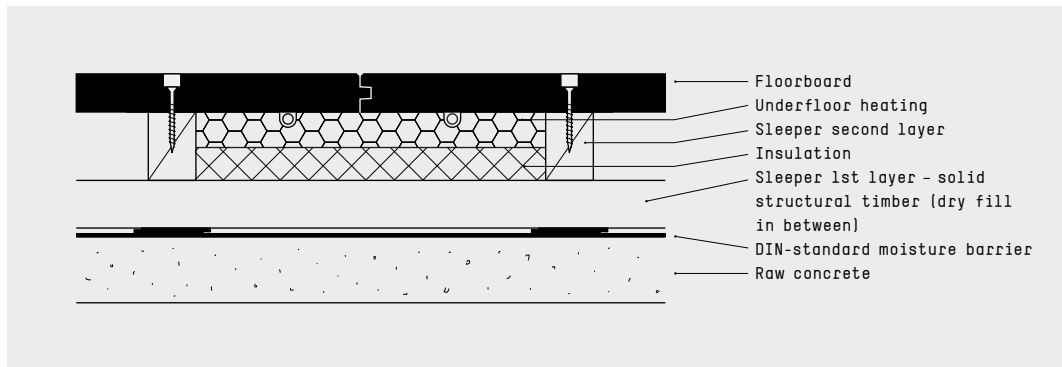

Figure 5: Screwing on dry construction underfloor heating system

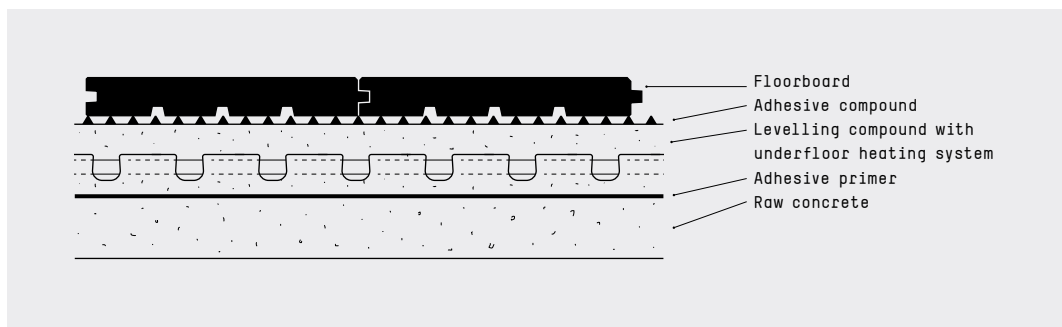

Figure 6: Screwing on thin-layer screed underfloor heating system

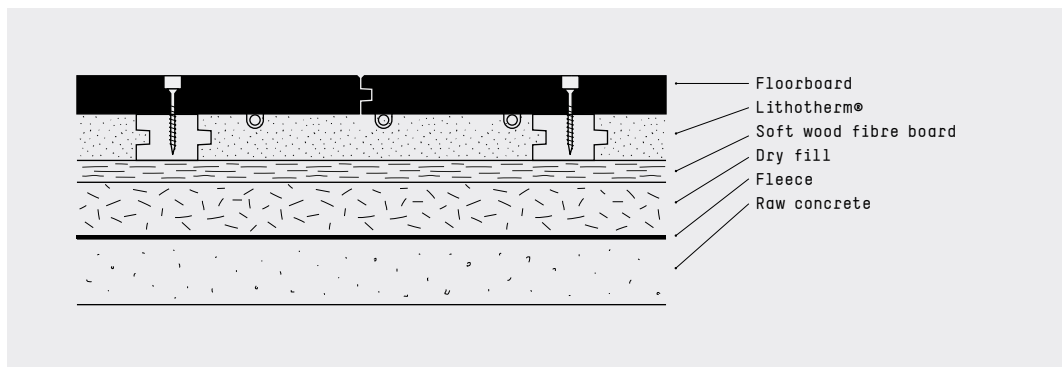

Figure 7: Screwing on Lithotherm®

]

3. Exposed joints

pur natur floorboards can be laid close together - without exposed joints - or with a small distance between the individual floorboards - with exposed joints. This decision influences the appearance and the work steps to be carried out and must therefore be made before laying.

From a design point of view, exposed joints emphasise the lines and thus the length of the floorboards, whereas laying without exposed joints creates a flatter impression in the room.

From a functional point of view, exposed joints create additional freedom of movement for acclimatisation of each floorboard. The distance from the wall can therefore be smaller when laying with an exposed joint than when laying without an exposed joint. Please note our specifications in Table 13 «Recommended wall clearances».

In principle, all pur natur floorboards can be laid with exposed joints, regardless of whether the floorboards are in fixed or mixed widths, in room lengths or random lengths, in a solid or 3-layer structure. In the case of solid floorboards with a width of 300 mm or more, laying with exposed joints is absolutely necessary. To see whether you can lay your floorboards with or without exposed joints, please see Table 11 «Necessity of exposed joints».

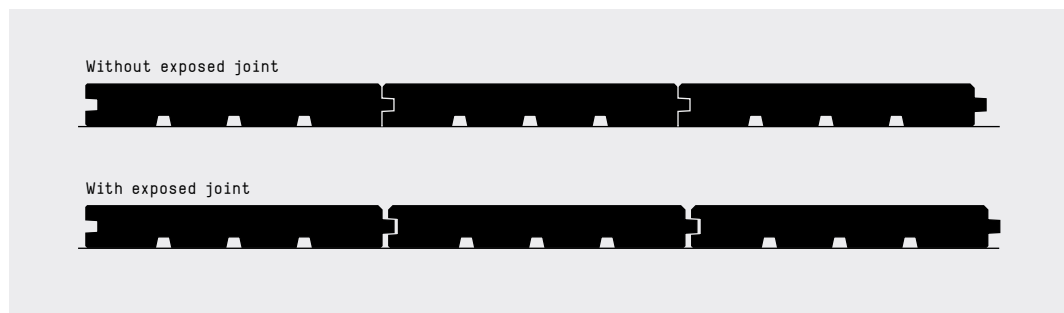

Figure 8: Laying with and without exposed joints



Attention: Solid floorboards with a width of 300 mm or more must be laid with exposed joints!

]

4. Laying the floorboards

4.1 General information

There are basically two ways of fixing pur natur floorboards to the subsurface; screwing and gluing.

With a screw connection, the floorboards are fastened to the subsurface with screws - this method does not require any additional materials. In the case of full-surface gluing, the floorboards are bound to the subsurface with adhesive.

We recommend screwing the floorboards where technically and functionally possible and reasonable. On some subsurfaces such as screeds with underfloor heating, full-surface gluing makes more sense and is therefore preferable. The following table shows which laying method is suitable for which floorboards or subsurfaces.

Laying methods for different subsurfaces

Laying method	Sleepers / joists	OSB panels (at least 22 mm)	Concrete / screed
Screwing from above	✓ mandatory at floorboard width > 300 mm	✓ mandatory at floorboard width > 300 mm	-
Concealed screw connection	✓ up to 300 mm floorboard width	✓ up to 300 mm floorboard width	-
Full-surface gluing	-	✓	✓

Table 2: Laying method by subsurface



pur natur floorboards are not suitable for click parquet flooring and can only be laid «floating» under certain conditions. We are happy to help if you have any questions.

4.2 Laying method

Screwing from above

This type of screw connection is suitable for all pur natur floorboards. The floorboards are screwed vertically to the subsurface from above on both long sides. The recessed screw holes are then closed with wooden plugs.

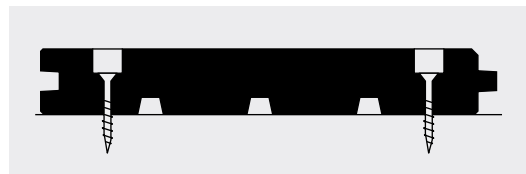

Concealed screw connection

Floorboards up to 300 mm wide can be screwed in a concealed manner. Here, the floorboards are screwed to the subsurface at a 45-degree angle through the tongue. The next floorboard covers the screws of the previous one.

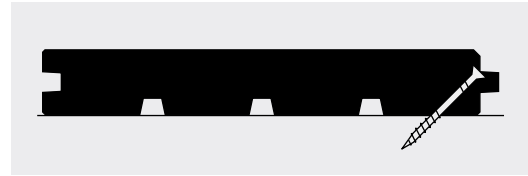

IMPORTANT: The first and last floorboard in the room must be screwed from above towards the end of the wall.

Full-surface gluing

All pur natur floorboards can be glued to the subsurface using the adhesives recommended by us. The floorboards are laid individually in a prepared adhesive bed and weighted to dry.

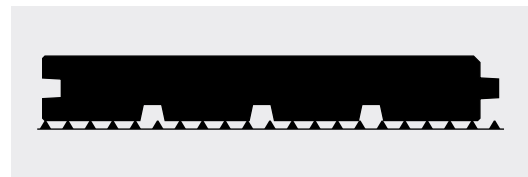

Advantages and disadvantages of the laying methods

Laying method	Advantages	Disadvantages
Screwing from above	<ul style="list-style-type: none"> • Very stable fixation, as the floorboards are screwed to the subsurface in two positions for each connection point. • Floorboards «bend» less than with concealed screws. • It is also possible to dismantle individual floorboards without much disruption. 	<ul style="list-style-type: none"> • The laying effort is slightly higher than with concealed screws. • Complete dismantling more complex than with concealed screw connections.
Concealed screw connection	<ul style="list-style-type: none"> • The screws are invisible. • Laying is quick. 	<ul style="list-style-type: none"> • Non-destructive dismantling of individual floorboards is not possible.
Full-surface gluing	<ul style="list-style-type: none"> • Very good impact noise behaviour, since the adhesive acts as a decoupling. • Low installation height, since no substructure is required. • Overall extremely stable fixation. 	<ul style="list-style-type: none"> • Requires precise work, as the gluing can only be corrected with great effort. • Dismantling the floorboards is extremely time-consuming; complete destruction of the floorboards and damage to the subfloor are unavoidable.

Table 3: Laying method advantages/disadvantages

4.3 Basic laying procedure

Make careful preparations for laying pur natur floorboards and observe the following information and processes:

1. Check room climate and prepare subsurface

The room climate must meet our specifications and the subsurface must be prepared according to our specifications – see chapter «Important notes on preparation».

2. Careful handling of pur natur floorboards

pur natur floorboards can be very long and very heavy. Depending on the length of the floorboards, two people should work with them. When laying the prepared floorboards, make sure you lay them carefully on the subsurface or the sleepers. Be careful not to bump into walls or other hard objects (pillars, joists, tools, etc.). Pay attention to the floorboard edges when handling – always lift the floorboards fully when moving them.

3. Special features of room-length floorboards

Laying room-length floorboards is demanding and requires particularly precise working, especially in combination with a surrounding shadow gap. If a floorboard is cut too short, there is no way to lengthen it again – it is and will remain too short. Long floorboards may have tension that needs to be straightened using tension belts. Logistics to and on the construction site are often a challenge that should not be underestimated. Depending on the length of the floorboards, two to four people are required to lay them.

4. Prepare the workstation and stack the floorboards sorted lengthwise

Prepare a workstation with sufficient space for the precise sawing and handling of the floorboards.

With room-length floorboards, remember that they are longer than the actual length of the room when delivered. In addition to the length buffer ordered, we manufacture all floorboards with an additional length of 3-5 cm free of charge.

If you have different lengths of floorboard, we recommend stacking the floorboards in three to four stacks: one stack for short floorboards, one for medium-length floorboards, and one for long floorboards. Ideally, lay the longer floorboards in large rooms to reduce the number of butt joints. Shorter floorboards are suitable for smaller rooms or for attaching to floorboard strips.

5. Floorboard selection and sorting

In order to achieve the most harmonious laying pattern and floor look, it is advisable to sort the floorboards visually. Before cutting and laying, the floorboards must be checked individually, several floorboards laid out next to each other in the room and sorted until the optimal laying pattern is achieved. This helps you determine whether, for example, floorboards with a higher amount of knots are laid in an edge area or floorboards with a lower percentage of knots are laid in a visible area.

We recommend stacking the floorboards in laying order and strongly advise against laying the floorboards in the order in which they are delivered in the package.

6. Specify a laying axis

Define an axis as the starting point for laying, along which you lay the first floorboard or floorboard strip. Walls or corridors are suitable as laying axes, but the laying axis must be chosen according to the individual situation.

In large rooms (e.g. offices or exhibition rooms), this axis can also be placed in the middle of the room; the floorboards are then laid to the left and right of it. This is the best way to compensate for any differences in room width or wall curvatures.

ATTENTION: A laying axis in the middle of the room only works with full-surface gluing or screwing - not with concealed screwing!

If possible, draw the laying axis on the subfloor. This axis determines the precision and appearance of the installation. Any errors or deviations can accumulate towards the wall or the edge. A laser spirit level or plumb line is suitable as an aid.

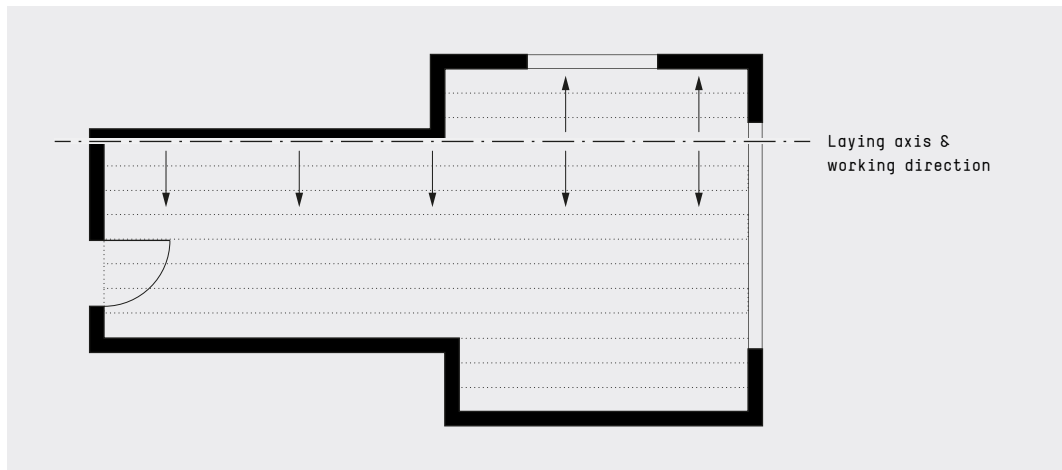

Figure 9: Example of a laying axis in a room

7. Exact measurement of the room length

Measure the length of the room to be floorboarded accurately, ideally using a laser measuring device. Bear in mind that rooms are not always 100% square. Differences in length within the same room are normal and not uncommon. Differences of several centimetres can occur, especially in old buildings. Therefore, only saw one floorboard at a time. Do not saw all floorboards at once.

It may be that a curvature of the wall where a floorboard ends can be compensated for with a slanted saw cut.

8. Transferring the room length to the floorboards

Place the floorboard to be laid on the trestles. Accurately transfer the measured room length onto the floorboard using a square and pencil. If you have to or want to saw both sides (e.g. to cut a piece off at the front end if you have enough additional length), saw one side first and then transfer the final length.

When marking the length, note the required wall clearances!

The following applies: Floorboard length = room length - (2 × wall distance)

Example: If the measured room length is 10,000 mm and the distance to the wall (on each side of the room) should be 10 mm, then the floorboard must be cut to exactly 9,980 mm.

If you start laying by a wall, also note the alignment of the floorboard (groove to the wall!) when transferring the length.

9. Cutting the floorboards

When sawing the floorboards, pay attention to the cutting width of the saw blade (usually approx. 2mm) and to saw on the correct side of the marked line! A stop or guide rail is absolutely necessary for a clean, right-angled cut. Always make sure you have a sharp saw blade so that there are no tears on the top of the floorboard.

When sawing, if a floorboard is sawn off too short, then it is too short - it is impossible to lengthen it again!

When cutting the last floorboard to size, we recommend tilting the saw blade so that it is easier to insert the floorboard on the wall side.

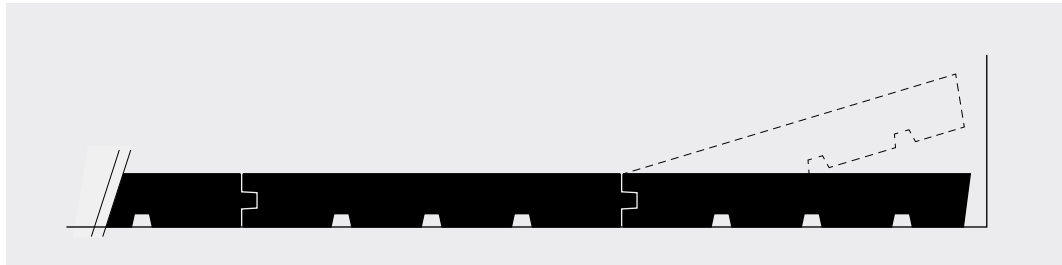

Figure 10: Tilted cut of the last floorboard towards the wall

IMPORTANT: Always consider the cutting width of the saw blade when marking and sawing!

10. Incorporating recesses

Recesses on columns, door sills, window embrasures, floor boxes and the like may have to be incorporated into floorboards. To avoid mistakes, we recommend marking these recesses on the upper side (visible side) of the floorboard. To do this, measure the required recess, add the desired distance from the wall and transfer this recess to the floorboard to be altered. Use a (jig)saw to cut the recess if the original grain is to be retained or the recess piece is to be used again later (e.g. for floor tanks). If the recess is not to be used again, the cut can be made with a router.

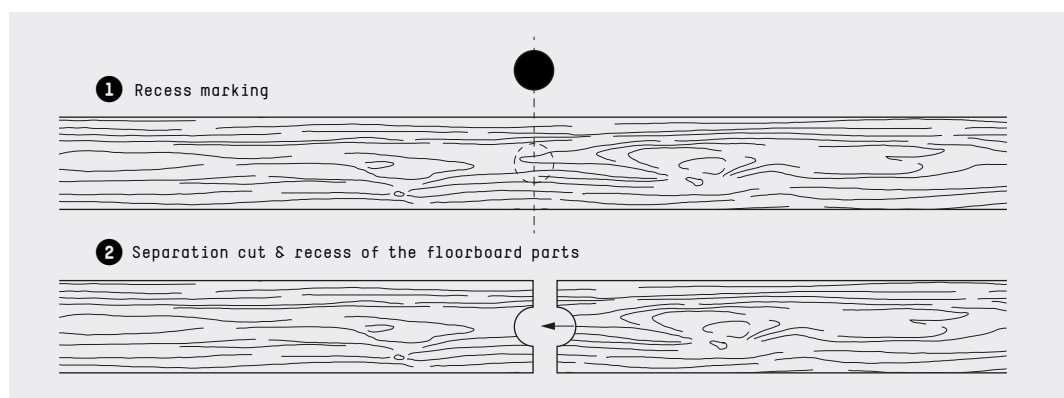

Figure 11: Cutting recesses in floorboards

11. Spacers for exposed joints

To avoid pressure points, when laying floorboards with an exposed joint, use spacers with a wide contact surface according to our recommendation (see Table 12 «Recommended exposed joint widths»). Insert these between the floorboards (above the tongue and groove).

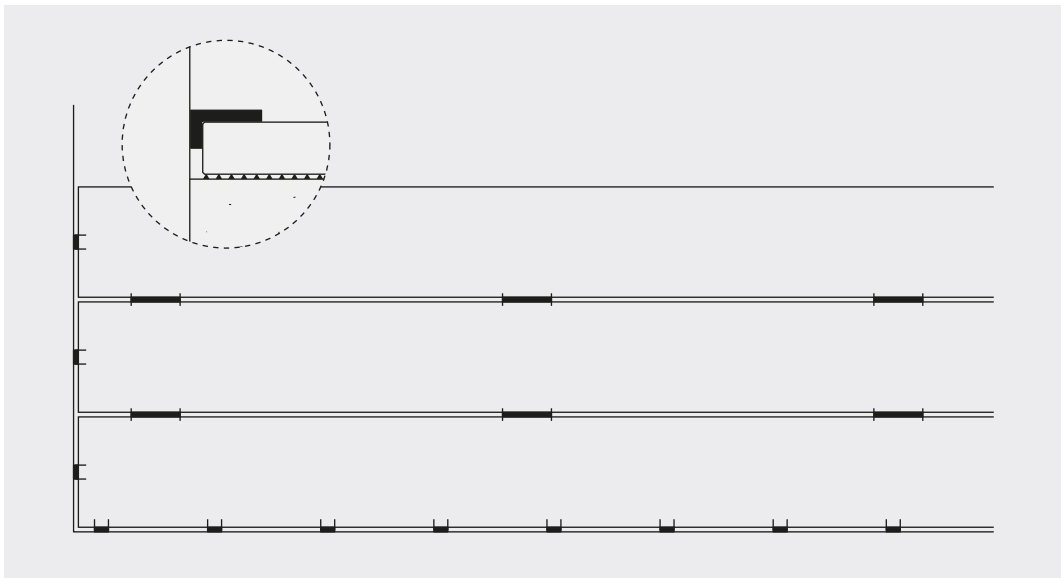

Figure 12: Spacers to the wall and between the floorboards

12. Knocking or tightening floorboards together

Slight curvatures and tensions in the floorboards are natural, can occur occasionally and do not constitute grounds for complaint. Use strong parquet tension belts with wide supports to bring the floorboards close together or to create and ensure an even joint width.

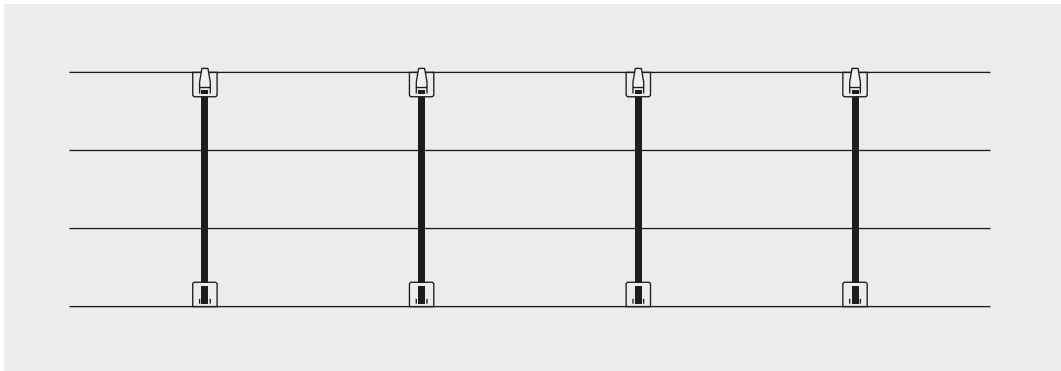

Figure 13: Tensioning of the floorboards with tension belts

]

5. Screwing from above

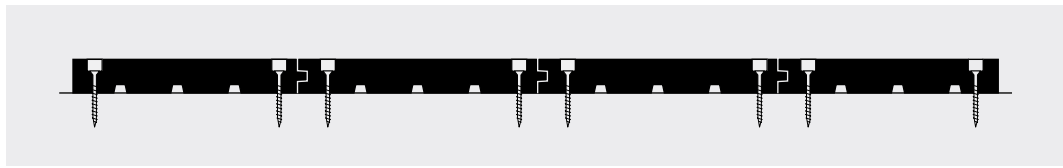

Figure 14: Screwing from above

IMPORTANT: pur natur floorboards may only be laid if the necessary climatic conditions are met and the subsurface quality meets the pur natur specifications.

When screwing from above, proceed as follows:

1. For room-length floorboards:

Lay the first floorboard, cut to room length, with the groove on the previously marked laying axis.

For floorboards of different lengths:

Lay the first floorboard with the groove on the previously marked laying axis.

If the laying axis is a wall, note the wall clearances (see Table 13 «Recommended wall clearances») and work with spacers.

2. Drill a 6-10 mm deep plug hole from above into the floorboard widthways on both sides of the floorboard with a 15 mm-diameter Forstner bit and the recommended screw spacing to the floorboard edge (see Table 8 «Screw spacing to the floorboard edge»).
3. Now pre-drill the screw hole in the middle of this hole - use a 4 mm-diameter wood drill bit. (Caution: only drill through the floorboard, not into the substructure!). Vacuum the borehole.
4. Screw the floorboard to the subsurface or substructure using the appropriate screw (see Table 5 «Screw size for screwing from above»).
5. Use this method to fasten the floorboard lengthwise on both sides. The screw spacing results from the spacing of the substructure; we recommend a distance of 60-80 cm for solid subsurfaces (see Table 7 «Screw distances»). The maximum distance is 100 cm.
6. **For room-length floorboards:**
Place the next floorboard on the previous floorboard and push them close together. When laying with exposed joints, work with spacers between the floorboards. Long floorboards can have tension that you have to compensate for with the help of tension belts. Fasten the next floorboard as described above.

For floorboards of different lengths:

Complete the floorboard strip by selecting a suitable floorboard and butting it to the front end of the floorboard that has already been laid. When selecting the floorboards, make sure that there is a harmonious transition at the floorboard joint. Tightly push the tongue and groove connection on the front end together. Keep an eye on the alignment to the laying axis. Fasten the floorboard as described above. Random-length pur natur floorboards are manufactured in such a way that the front-end butt joint fits exactly and there are no gaps.

If a floorboard is long enough to complete the floorboard strip, cut it to the appropriate length. Note the cutting width of the saw blade and the distance from the wall! If the end piece is longer than 30 cm, it can be used as the beginning piece in the following floorboard strip.

For the following floorboard strip, place the end piece or the new floorboard on the previous floorboard and push them tightly together so that the tongue and groove connection is closed. Long floorboards can have tension that you have to compensate for with the help of tension belts. Screw the floorboard to the subsurface as described above. Repeat the work steps for each floorboard of the floorboard strip. When laying with exposed joints, work with spacers between the floorboard strips.

7. Repeat the work steps for all other floorboards or floorboard strips. When laying with exposed joints, work with spacers in between.
8. Saw the last floorboard or floorboard strip lengthways according to the remaining room width (allow for the distance from the wall), place it on the previous one and screw it like the remaining floorboards. If the floorboard is cut lengthwise, any tension in the wood can be reduced, causing the floorboard to bend. You must compensate for this using parquet tension belts.
9. When cutting the last floorboard to size, we recommend tilting the saw blade so that it is easier to insert the floorboard on the wall side.
10. Once all the floorboards are screwed, glue a suitable wooden plug into each screw hole with waterproof glue. To do this, put some wood glue in the plug hole and hammer in the wood plug with a rubber mallet. Once the glue has dried, grind off the protruding plugs with a grinder. Matching wooden plugs in Douglas fir and oak are available from pur natur.
11. If the floorboards are not to be treated immediately after they have been laid, cover them with permeable floor protection fleece (available from pur natur) or floor cardboard (400 g/m²) for protection. The floor is very delicate when untreated. If others intend to walk on the floor before the surface is treated, make sure that the floor is adequately protected. Coffee or water stains can easily occur, which must be washed out or sanded before surface treatment.

TIP: If you choose wooden plugs that resemble the colour and grain of the floorboard as much as possible at the respective point, the screw points will be almost invisible.



For floorboards with a thickness of 16-22 mm, the plug hole is only drilled about 6 mm deep so the floorboard is still strong enough to hold the screw!

]

6. Concealed screw connection

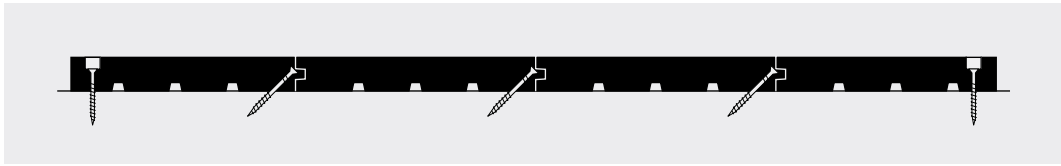

Figure 15: Concealed screw connection

IMPORTANT: pur natur floorboards may only be laid if the necessary climatic conditions are met and the subsurface quality meets the pur natur specifications!

For a concealed screw connection, proceed as follows:

1. For room-length floorboards:

Place the first floorboard, prepared to the length of the room, with the groove facing the wall. Use spacers to maintain the required wall clearances (see Table 13 «Recommended wall clearances»).

For floorboards of different lengths:

Place the first floorboard with the groove facing the wall. Use spacers to maintain the required wall clearances (see Table 13 «Recommended wall clearances»).

2. Drill a 6-10mm-deep plug hole from above into the floorboard (only!) on the wall side of the floorboard with a 15mm-diameter Forstner bit and the recommended screw spacing to the floorboard edge (see Table 8 «Screw spacing to the edge of the floorboard»).
3. Now pre-drill the screw hole in the middle of this hole - use a 4mm-diameter wood drill bit. (Caution: only drill through the floorboard, not into the substructure!). Vacuum the borehole.
4. Screw the floorboard to the subsurface or substructure using the appropriate screw (see Table 5 «Screw size for screwing from above»).
5. Fasten the first floorboard lengthwise on the wall side in this way. The screw spacing results from the spacing of the substructure; we recommend a distance of 60-80 cm for solid subsurfaces (see Table 7 «Screw distances»). The maximum distance is 100 cm.
6. Now screw the floorboard lengthwise at an angle of 45° through the tongue to the subsurface using a suitable screw (see Table 6 «Screw size for concealed screw connections») on the side facing the room. The screw spacing results from the spacing of the substructure; we recommend a distance of 40-50 cm for solid subsurfaces (see Table 7 «Screw distances»). Be careful not to overtighten the screw - there is a risk of the tongue snapping or breaking off. Therefore, screw the last few turns carefully, ideally with a cordless drill/driver with an integrated torque limiter.
7. **For room-length floorboards:**
Place the next floorboard on the previous floorboard and push them close together so that the tongue and groove connection is closed. Long floorboards can have tension that you have to compensate for with the help of tension belts. Screw all subsequent floorboards to the subsurface on the room side using the tongue as described above. When laying with exposed joints, work with spacers between the floorboards.

For floorboards of different lengths:

Complete the floorboard strip by selecting a suitable floorboard and butting it to the front end of the floorboard that has already been laid. When selecting the floorboards, make sure that there is a harmonious transition at the floorboard joint. Tightly push the tongue and groove connection on the front end and ensure the exact alignment on the wall. Use spacers to keep the distance from the wall. Fasten the floorboards of the first floorboard strip as described above on the wall side from above and on the room side screwed through the tongue.

If a floorboard is long enough to complete the floorboard strip, cut it to the appropriate length. Note the cutting width of the saw blade and the distance from the wall! If the end piece is longer than 30 cm, it is used as the beginning piece in the following floorboard strip.

For the following floorboard strip, place the end piece or the new floorboard on the first floorboard of the previous floorboard strip and push them close together so that the tongue and groove connection is closed. Long floorboards can have tension that you have to compensate for with the help of tension belts. Screw the floorboard to the subsurface on the room side through the tongue as described above. Repeat the work steps for each floorboard of the floorboard strip. When laying with exposed joints, work with spacers between the floorboard strips.

8. Saw the last floorboard or floorboard strip lengthways according to the remaining width of the room (take into account the distance from the wall), place it on the previous one and screw it to the wall «from above», exactly as you fastened the first floorboard on the opposite side of the wall. If the floorboard is cut lengthwise, any tension in the wood can be reduced, causing the floorboard to bend. You must compensate for this using parquet tension belts.

When cutting the last floorboard to size, we recommend tilting the saw blade so that it is easier to insert the floorboard on the wall side.

9. If the floorboards are not to be treated immediately after they have been laid, cover them with permeable floor protection fleece (available from pur natur) or floor cardboard (400 g/m²) for protection. The floor is very delicate when untreated. If others intend to walk on the floor before the surface is treated, make sure that the floor is adequately protected. Coffee or water stains can easily occur, which must be washed out or sanded before surface treatment.

IMPORTANT: To enable easy placement of the following floorboard's groove on the tongue of the previous floorboard, small screw heads are necessary, which can be easily countersunk into the wood. Use the screws we recommend.

]

7. Full-surface gluing

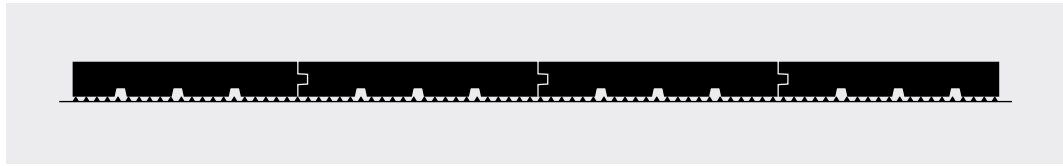

Figure 16: Full-surface gluing

IMPORTANT: pur natur floorboards may only be laid if the necessary climatic conditions are met and the subsurface quality meets the specifications of both pur natur and the glue manufacturer.

Full-surface gluing requires precise work, since it is impossible, or very difficult, to detach the floorboards afterwards - damage cannot be ruled out. We generally recommend gluing the floorboards room by room.

The full-surface gluing of pur natur floorboards is divided into two work phases: firstly, the subsurface preparation and priming, secondly, the laying including the drying time.



Full-surface gluing of a floorboarded floor should only be carried out by experienced specialist companies!

7.1 Preparing the subsurface

The preparation of the entire subsurface is a prerequisite for gluing the floorboards. Proceed as follows:

1. Check and prepare the subsurface

Check the condition and evenness of the subsurface, taking into account our specifications from Table 9 «Subsurface quality when gluing». The specifications must be met. The subsurface must be sanded, dust-free and clean. Severe unevenness in the screed must be levelled out with levelling compound; the deviation must not be greater than 2 mm on a 2 m level.

2. Apply primer

The primer binds remaining dust and ensures optimal adhesion. If applied twice, the primer also acts as a vapour barrier. Apply the primer we recommend (Table 10 «Adhesives, primers and drying time») with a roller and allow to dry as specified. The consumption for the first application is approx. 125 g/m².

IMPORTANT: Primer is no substitute for a building seal in line with DIN 18195 Part 4!



The floorboards must be glued within 72 hours of applying the primer. If this time is exceeded, the primed subsurface must be sanded and primed again!

7.2 Laying the floorboards

Once the subsurface has been prepared, the floorboards can be laid. Lay the floorboards in several laying sections until the entire floor area has been laid. Each laying section is laid in three steps: first «dry» laying and marking of the adhesive surface, then removal of the floorboards and application of the adhesive compound, finally laying of the floorboards and drying time.

The laying sections should be wide enough so that you can easily handle the floorboards and not exceed the «open time» of the adhesive (approx. 30 minutes) when laying the floorboards. We recommend a width of approx. 50-100 cm or two to four floorboard strips, depending on the width of the floorboards.

Proceed as follows for each laying section:

1. For room-length floorboards:

Lay the first floorboard, prepared to room length, with the groove on the previously marked laying axis. If the laying axis is a wall, note the wall clearances (see Table 13 «Recommended wall clearances») and work with spacers.

For floorboards of different lengths:

Lay the first floorboard with the groove on the previously marked laying axis. If the laying axis is a wall, note the wall clearances (see table «Recommended wall clearances») and work with spacers.

IMPORTANT: In the case of full-surface gluing, the first floorboard must be and remain exactly aligned with the laying axis. Check this repeatedly, including during laying.

2. For room-length floorboards:

Place the next floorboards for the first laying section one after the other on the previous floorboard and push them close together so that the tongue and groove connection is closed. Long floorboards can have tension that you have to compensate for with the help of tension belts. When laying with exposed joints, work with spacers between the floorboards.

For floorboards of different lengths:

Complete the floorboard strip by selecting a suitable floorboard and butting it to the front end of the floorboard that has already been laid. When selecting the floorboards, make sure that there is a harmonious transition at the floorboard joint. Push the tongue and groove connection close together on the front end and keep an eye on the exact alignment on the wall. Use spacers to keep the distance from the wall. If a floorboard is long enough to complete the floorboard strip, cut it to the appropriate length. Note the cutting width of the saw blade and the distance from the wall! If the end piece is longer than 30 cm, it can be used as the beginning piece in the following floorboard strip.

For the following floorboard strip, place the end piece or the new floorboard on the previous floorboard and push them tightly together so that the tongue and groove connection is closed. Long floorboards can have tension that you have to compensate for with the help of tension belts. Repeat the work steps for each floorboard of the floorboard strip. When laying with exposed joints, work with spacers between the floorboard strips. Complete the laying section in this way.

3. Now mark the adhesive surface on the floor (e.g. with a pencil) over the entire length, parallel to the last floorboard or floorboard strip. We recommend that you mark the adhesive surface 1-2 cm narrower so that no adhesive spills out from under the last floorboard later.

4. Completely dismantle the previously laid floorboards and stack them in the appropriate laying order.
5. Use a notched trowel to apply the adhesive recommended by us to the subsurface in the marked area (notched trowel no. 5 for 3-layer floorboards, notched trowel no. 14 for solid floorboards). An ordinary painter's spatula will help you scoop and scrape out the glue bucket. Depending on the floorboard, you need between 1.1 kg and 1.6 kg of adhesive per square metre of floor. Please observe the manufacturer's precise instructions and regulations.

IMPORTANT: The «open time» of the adhesive is approx. 30 minutes. Please check regularly that no skin forms on the surface. Avoid a longer «standing time» and do not put any more floorboards in the adhesive after 30 minutes!



Under no circumstances should you put glue or floor adhesive in the longitudinal tongue and groove connection of the floorboards. This is to maintain their freedom of movement!

6. Now lay the floorboards of the respective laying section one after the other in the adhesive bed. To do this, proceed as described in Steps 1 and 2. It is best to work in pairs and «in front of the surface» so that you can easily push the floorboards away towards the wall or the previous floorboard.

To insert each floorboard, hold each floorboard over the adhesive bed and lower the groove to latch onto the tongue of the previous floorboard along its entire length. Then move the floorboard down into the adhesive bed and lay it down. Work carefully and precisely - subsequent corrections are difficult.

7. Push each inserted floorboard to the previous one to close the tongue and groove connection. Use parquet tension belts to push the floorboards close together. To insert subsequent floorboards, you can loosen the tension belts for a short time, but you must then tension the laying section again until the adhesive has dried so much that the floorboards can no longer be detached (approx. one hour). When laying with exposed joints, work accordingly with spacers between the floorboards.

If it is necessary to move the floorboard lengthwise or crosswise, for example to align it with the wall, use suitable tension belts, pull bars or tapping blocks. Move the floorboards as little as possible.

8. Immediately after installation, remove excess adhesive next to the floorboards before it dries.
9. After inserting and closing the tongue and groove connection, press the floorboards completely into the adhesive bed in order to e.g. avoid cavities. To do this, walk up and down on the floorboards and then weigh them down with suitable weights (e.g. filled buckets of glue, tiles, etc.). A weighting of approx. 15-20 kg per m² applies as a guideline.

10. Saw the last floorboard or floorboard strip lengthways according to the remaining room width (allow for the distance from the wall!) and glue it like the other floorboards. If the floorboards are cut lengthwise, any tension in the wood can be relaxed, causing the floorboard to bend. You must compensate for this using parquet tension belts.

When cutting the last floorboard to size, we recommend tilting the saw blade so that it is easier to insert the floorboard on the wall side.

11. After laying the floorboards, the adhesive must dry. After a setting time of approx. 24 hours, loads can be put on the floors. Surface treatment is possible after 48 hours when using PU, SMP or SPU adhesives.

IMPORTANT: Nobody may walk on or put loads on the glued floorboards during the drying time.

12. If the floorboards are not to be treated immediately after they have been laid, cover them with permeable floor protection fleece (available from pur natur) or floor cardboard (400 g/m²) for protection. The floor is very delicate when untreated. If others intend to walk on the floor before the surface is treated, make sure that the floor is adequately protected. Coffee or water stains can easily occur, which must be washed out or sanded before surface treatment.

]

8. Edging

By edge finish, we mean the transition from floor to wall. There are various ways of creating this edge finish.

8.1 Shadow gap

A shadow gap edge finish is a sophisticated, elegant floor-to-wall transition that leaves a gap between the floorboards and the wall. This shadow gap can remain «open» or be closed. It is closed by pressing in suitable cords and/or by filling the joint with natural stone silicone.

The execution of a floor with a shadow gap requires maximum precision when laying the floorboards or clean trimming or milling of all edges before the surface treatment. This requires special tools and the appropriate expertise.

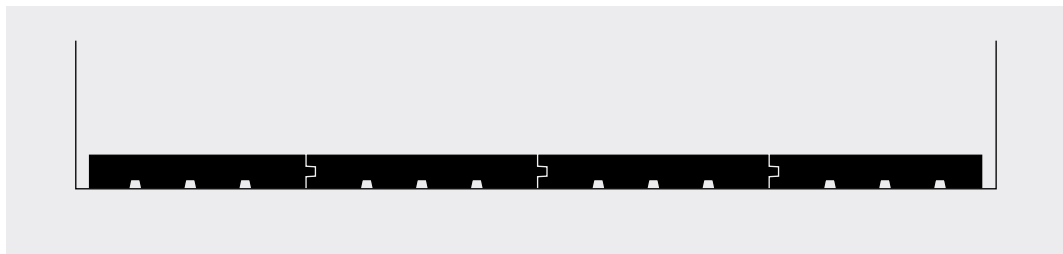

Figure 17: Shadow gap



Conventional sanitary silicone must not be used to fill the shadow gap!

8.2 Skirting boards

Classic skirting boards

A skirting board is a classic floor finish. It bridges the transition from the floorboard floor to the wall and thus covers the joint and any inaccuracies on the floorboard edges. Wall distances greater than 10mm can only be covered with a skirting board. pur natur offers two types of skirting board for your floor: skirting made of the same wood as the floorboards or skirting in white (RAL 9016).

We recommend screwing, nailing (with a hammer or nail gun) or gluing the skirting boards to the wall. Factors such as the condition of the walls or their surface material (plaster, wallpaper, etc.) determines which method is best. The skirting board must sit flush on the floorboards, but must not be glued or screwed to them so the floorboards can freely adapt to the room climate.

Skirting boards are put in place after the laying and surface treatment of the floorboards.

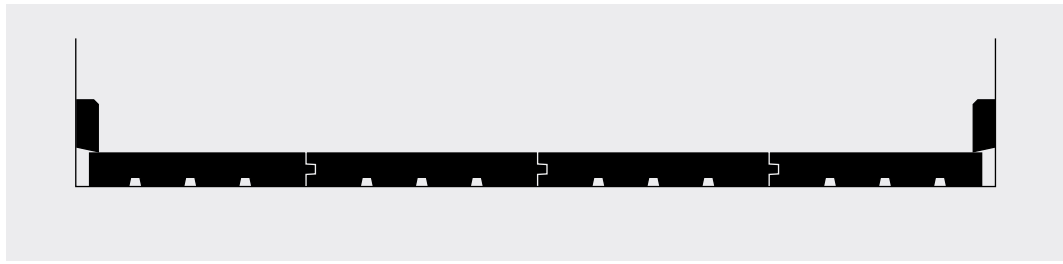

Figure 18: Skirting board



Skirting boards must not be glued or bound to the floorboards in any way!

Flush skirting boards

Another type of edge finish is the so-called «wall-flush skirting board». With this variant, the thickness and height of the skirting board is left out at the foot of the wall. After laying the floor, the board is usually clicked into an existing profile. With this type of skirting board, coordination is required with both the architect and the drywall builder, as appropriate structural preparations must be made for this. pur natur does not offer any services in this area.

Wall-flush skirting boards are put in place after the laying and surface treatment of the floorboards.

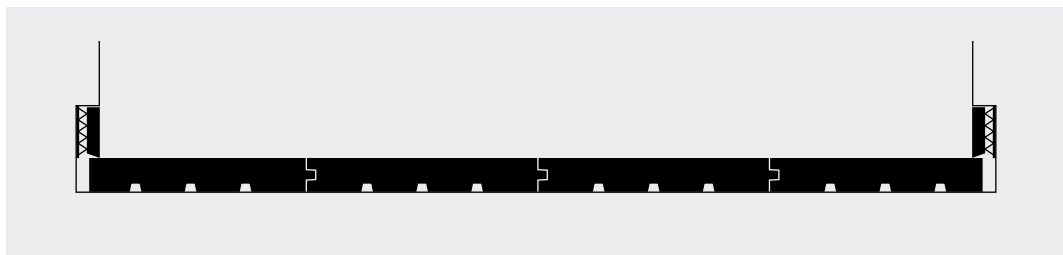

Figure 19: Wall-flush skirting board

]

9. Professional tips

Like all things in life, when it comes to outstanding floorboards, it's the small things that make the difference. With our experience from hundreds of projects, we give you the following tips for an excellent installation result:

- > **Leave as little to chance as possible.** Avoid any room for interpretation and thus misunderstandings by planning the exact details of the installation in advance and communicating them to everyone involved.
- > **Avoid frayed board ends, especially when laying with a shadow gap.** Always saw the floorboards with a sharp saw blade. For tricky cuts, you can also stick Tesa adhesive tape on the cut edge before sawing to minimise the risk of fraying when sawing.
- > **It is best to use a bevel to transfer angles that deviate from 90 degrees.**
- > **For tricky recesses, make a template or perform a test cut.** For example, use a left-over piece of floorboard and adjust it before you saw «on the original». A contour gauge can also be helpful for recesses.
- > **When handling the floorboards, protect their edges by always lifting the floorboards fully.** The edges are very sensitive, especially on sharp-edged floorboard designs.
- > **Keep the construction site clean.** Small stones or dirt can quickly cause scratches on the visible sides of the floorboards.
- > **Use trolleys to store the floorboards on site.** This makes your work easier and helps you manage space.
- > **Use strong tension belts to bring the floorboards tight together.** Natural stresses in the wood can lead to warping with an amplitude of a few millimetres, especially in the case of large-size, long floorboards. In order to lay such floorboards in a straight line, stable tools are required that can withstand the forces that are generated.
- > **Lay the first floorboard strip in an absolutely straight line.** This is extremely important, especially with floorboards of different lengths. A guide line or a cross-line laser can help here, for example. If the first row is not laid straight, errors can accumulate and ultimately lead to major inaccuracies and problems.
- > **Use the same laying method for the entire floor (or at least for each floor).** Different laying or fastening methods can lead to unwanted movements in the floor.
- > **For slight unevenness when gluing 3-layer floorboards, use a STAUF No. 14 notched trowel and/or STAUF PUK-455 lightly foaming adhesive.** Although this increases the adhesive consumption, it is a better way of evening out small bumps. Please note our specifications for subsurface quality!
- > **Take your time to create your harmonious floor pattern.** During installation, check whether the next floorboard looks like it matches with the previous one. Do this also with floorboards that are jointed lengthwise.

10. Reference tables

10.1 Sleeper distances

The following sleeper distances are to be understood as guide values. The first and last row of sleepers are laid at a distance of 5–8 cm from the walls. The second row of sleepers is laid at a maximum distance of 50 cm from the first or last row.

Wood type	Construction	Strength	Private properties	Business	Museums or similar
Douglas fir	3-layer	16/21 mm	50 cm	45 cm	40 cm
	Solid	28 mm	80 cm	70 cm	60 cm
		35 mm	100 cm	80 cm	70 cm
Oak	3-layer	16/21 mm	50 cm	45 cm	40 cm
	Solid	22 mm	60 cm	50 cm	40 cm
		28 / 30 mm	80 cm	70 cm	60 cm

Table 4: Sleeper distances

10.2 Screw sizes

The screw length must always be adjusted to the strength of the material into which the screw is screwed (board thickness + subfloor or substructure). For example, if 16 mm-thick 3-layer floorboards are screwed into 22 mm OSB boards from above, the maximum screw length is 30 mm.

Depending on the laying method, we recommend the following screw sizes:

Screw sizes when screwing from above

Floorboard construction	Strength	Sleeper / joist substructure	OSB panel / chip-board (min. 22 mm)	Concrete / screed
3-layer	16/21 mm	5.0 × 50 mm	5.0 × 35 mm	⊗
Solid	22 mm	5.0 × 60 mm	5.0 × 40 mm	⊗
	28 / 30 mm	5.0 × 60 mm	5.0 × 40 mm	⊗
	35 mm	5.0 × 60 mm	5.0 × 40 mm	⊗

Table 5: Screw sizes when screwing from above

Screw sizes for concealed screws

Floorboard construction	Strength	Sleeper/joist substructure	OSB panel/chipboard (min. 22 mm)	Concrete/screed
3-layer	16/21 mm	3.2 × 50 mm	3.2 × 40 mm	⊗
Solid	22 mm	4.2 × 60 mm	4.2 × 45 mm	⊗
	28/30 mm	4.2 × 60 mm	4.2 × 45 mm	⊗
	35 mm	4.2 × 60 mm	4.2 × 55 mm	⊗

Table 6: Screw sizes for concealed screws

10.3 Screw distances

If the floorboards are screwed to a solid subsurface (e.g. OSB panels) and not onto sleepers, we recommend screwing at the following intervals:

Laying method	Screw spacing on OSB board/chipboard (thickness at least 22 mm)
Screwing from above	60 – 80 cm
Concealed screw connection	40 – 50 cm

Table 7: Screw spacing

10.4 Screw distance to floorboard edge

When screwing from above, we recommend the following distances between the screws and the floorboard edge, depending on the floorboard width:

Floorboard width	Screw distance to floorboard edge
200 mm	4.0 cm
250 mm	4.5 cm
300 mm	5.0 cm
350 mm	5.5 cm
400 mm	6.0 cm
450 mm	6.5 cm
500 mm	7.0 cm

Table 8: Screw distance to floorboard edge

10.5 Subsurface quality when gluing

For the gluing of par natur floorboards, the subsurface or screed must meet the following conditions. Compliance with these specifications is essential.

Measured values to be observed	
Residual moisture in screed The measurements must be taken at several points and logged!	< 1.8 CM for cement screeds with UH* < 2.0 CM for cement screed without UH* < 0.3 CM with anhydrite screed
Unevenness of the subsurface	+/- 2 mm on a 2 m level

Table 9: Subsurface quality when gluing

10.6 Adhesives, primers and drying time

For full-surface gluing, we generally recommend STAUF products that are label- and solvent-free and which have been certified as being in the Ecode ECl-R plus class by the GEV (Gemeinschaft Emissionskontrollierte Verlegewerkstoffe, Klebstoffe und Bauprodukte e.V. - Association for Emission-controlled Installation Materials) as very low-emission installation materials. The table below provides an overview of the primers, adhesives, quantity and notched trowels to be used with different types of floorboard.

Please also note the technical data sheets from STAUF, which we will be happy to make available to you. You can also find these on the STAUF website.

Floorboard type	Adhesive	Description	Recommendation
All	STAUF SPU 570	Hard single-component ISO 17178-compliant SPU parquet adhesive	High-quality all-round adhesive for all applications
Up to 250 mm wide	STAUF SPU 460	Hard single-component ISO 17178-compliant SPU parquet adhesive	Cheaper alternative to SPU 570 with good workability
All	STAUF PUK 455	Single-component ISO 17178-compliant polyurethane parquet adhesive	Lightly foaming - ideal for slight bumps or to avoid cavities
Solid floorboards 150 mm wide, 3-layer floorboards up to 250 mm wide	STAUF SMP 930	Hard-elastic single-component SMP parquet adhesive according to ISO 17178 for parquet	Inexpensive adhesive for her-ringbone parquet and narrow floorboards
Primer		Cement screeds: STAUF VPU-155 S Anhydrite screeds: STAUF VDP-130 or VDP-160	
Amount of adhesive & notched trowel		Solid floorboards 1400 - 1600 g/m ² with STAUF No. 14 notched trowel 3-layer floorboards 1150 - 1300 g/m ² with STAUF No. 5 notched trowel	
Drying time		At least 24 hours depending on the amount of adhesive	

Table 10: Adhesives, primers and drying time

10.7 Exposed joints

Need for exposed joints

The ability to lay the floorboards with or without exposed joints depends on the floorboard type and the floorboard width:

	up to 300mm width	from 300mm width
Solid floorboards	optional	mandatory
3-layer floorboards	optional	optional

Table 11: Need for exposed joint

Exposed joint widths

If you decide to lay floorboards with a exposed joint or if the selected floorboard width requires one, we recommend the following exposed joint widths. Spacers should be used to ensure that the joint width is maintained exactly. For 1-2mm wide joints, we recommend plastic Würth plates. For 1.5mm or 2.5mm wide joints, we recommend aluminium T-profiles with a length of at least 20 cm so that no pressure points arise when the floorboards are tensioned. All spacers should be clamped between the floorboards at a distance of approx. 50 cm.

Floorboard width	Exposed joint
200 mm	1.0 mm
250 mm	1.0 mm
300 mm	1.0 mm / 1.5 mm
350 mm	1.5 mm
400 mm	2.0 mm
450 mm	2.0 mm
500 mm	2.0 mm / 2.5 mm

Table 12: Recommended exposed joint widths

10.8 Wall clearances

Solid floorboards in particular expand or contract with fluctuating climatic conditions in the room. The floorboards only «work» to a negligible extent in length and almost exclusively in width. You need sufficient space for this.

Depending on the laying method and the covered width (usually the width of the room), we recommend the following distances from the wall:



Laying method	Covered width	Wall clearance
With exposed joint	any	5 mm
Without exposed joint	< 8 m	10 mm
	> 8 m	10 mm*

Table 13: Recommended wall clearances

*In rooms with large covered widths, an expansion joint of 10-15mm must be formed at a suitable point within the floor area. This should be discussed with the installer, based on the floor plan and the individual situation.

We recommend natural stone silicone as the expansion joint material. Alternatively, cork can be used. Other materials with similar properties are permitted. Sanitary silicone must not be used as it can cause discolouration with the wood.

]

11. Construction site check

The checklist below gives you an overview of the most important prerequisites for laying pur natur floorboards. The checklist is no substitute for reading the entire installation instructions and has no claim to completeness.

For builders

You must ensure the following points before instructing craftsmen to carry out the installation. If you instruct craftsmen to carry out the installation without observing these specifications, you cannot raise any legal claims in the event of any defects. In the absence of essential prerequisites, craftsmen are entitled to cease work and claim downtime and travel times.

For craftsmen

Please note that the necessary prerequisites and room climate conditions must be observed. Failure to observe these conditions can result in consequential damage, e.g. on the floor.

Have the client confirm the necessary conditions on the construction site before starting work. If the necessary conditions are not fulfilled, they must first be fulfilled before you can start the laying work.

It is imperative that you check the general building moisture, temperature, humidity and moisture in the subsurface or the substructure in accordance with our specifications.

11.1 Checklist prerequisites

Room climate

- > The building is dry and moisture-related work has been completed.
- > The humidity is 40-60 %, temperature at least 18 °C.
- > A heating protocol has been carried out and rooms are continuously heated for at least three weeks prior to installation.
- > For screed with underfloor heating, the building moisture is $\leq 1.8\%$ CM, for wooden substructures, the wood moisture is max. 10-12%.
- > Measurement protocols for subsurface moisture are adequately documented.
- > Evenness of the subsurface has been tested according to DIN and is no greater than 2mm on a 2m level.

Laying

- > **In summer:** floorboards should be laid immediately after delivery.
- > **In winter:** floorboards should acclimatise for 5-7 days in a dry, warm room.

12. Recommended tool

Anyone who abides by the following principle will enjoy laying their floorboards: make sure you have enough space, then laying it will be easy for you. Keep things tidy and set up workstations in advance. You will spend less time searching and instead «make space». Make sure you have enough space to handle the floorboards. The following is also essential for a clean laying result: Sharp tools are a must, blunt ones only lead to frustration. Blunt tools cause tears in the wood and impair the laying pattern. Therefore, always work with sharp tools.

Tools for laying pur natur floorboards:

Safety <ul style="list-style-type: none"> • Working gloves • Safety goggles • Ear protection • Knee pad • Dust mask 	Measuring and marking <ul style="list-style-type: none"> • Pencils • Ruler • Laser length gauge • Cross line laser • Ruler & tape measure • Square (long + short) and bevel • Spirit level (long + short) • 2 metre level • Marker
Sawing and milling <ul style="list-style-type: none"> • Working trestles • Plunge saw with stop rail and square • Jigsaw • Router • Hand planer • Vacuum cleaner • Shadow joint cutter (optional) 	Laying and tensioning <ul style="list-style-type: none"> • Parquet tension belts • Ceiling tensioner • Heavy hammer (1.5–2 kg) • Rubber mallet • Mallet and crowbar • Wall spacers • Exposed joint spacers (e.g. 1mm plates)
Screwing <ul style="list-style-type: none"> • 2 cordless screwdrivers + rechargeable batteries • Bit set • 15mm-diameter Forstner bit • 3.5–5mm-diameter wood drill set • Screws (according to screw recommendation) • Wooden plug • Wood glue 	Gluing <ul style="list-style-type: none"> • STAUF notched trowel No. 14 (for solid floorboards) • STAUF notched trowel No. 5 (for 3-layer floorboards) • Painter's spatula • STAUF primer (as recommended) • STAUF adhesive (as recommended) • Gloves
Grinding <ul style="list-style-type: none"> • Trio or Quattro grinder (e.g. from Lägler or BONA) • 410mm-diameter single disc grinder • Edge grinding machine (e.g. from Lägler, Mirka or Festool) • 100, 120 and 150 sanding meshes (for all sanding machines) • Sanding block with sandpaper 	Surface treatment <ul style="list-style-type: none"> • Buckets & wipers • Lye wiper with cover (for watering and leaching Douglas fir, for watering oak only) • Single disc grinder with pad attachment • Pad for single disc machine + suitable pad • Cotton cloths • Soap or oil as recommended • Shoe covers
Applying <ul style="list-style-type: none"> • Spatula & trowel • pur natur repair kit for the respective wood • Masking tape 	Miscellaneous <ul style="list-style-type: none"> • Moisture meter (wood and room moisture) • Brooms, shovels and waste bags • Waste bins • 50mm Tesa tape • Construction site radio

Table 14: Recommended tool

Disclaimer

These instructions are based on German law and regulations. The advice from pur natur exclusively refers to pur natur products. For advice on other building or construction phases such as insulation or moisture barriers and for advice on products from third parties, we expressly refer to the respective service provider or manufacturer. Since pur natur has no influence on the respective local conditions, nor on the execution quality of craftsmanship and the materials used, these instructions do not represent any form of guarantee. All illustrations are indicative. All errors and misprints reserved.

Contact

pur natur Holzprodukte

Ruthard Männle e. K.
Auf der Hausmatt 6
D-77736 Zell a. H.

+49 7835 426990
info@purnatur.com
www.purnatur.com

STAUF Klebstoffwerk GmbH

Oberhausener Straße 1
57234 Wilnsdorf

+49 2739 301-0
www.stauf.de